

船用泡沫消防卷盘站

FOAM HOSE REELS FOR VESSELS



泡沫消防卷盘 - 60 升/分 - DN25
Foam hose reel - 60 lpm - DN25

▶ 最大工作压力: PN16 / Working pressure: PN16

液罐 / Tank

▶ 材料: 不锈钢 / Material: stainless steel

消防枪 / Nozzle

▶ 材料: 铝合金 / Material: aluminium alloy

▶ 表面处理: 聚酯涂层和硬质阳极氧化

Surface treatment: polyester coated and hard anodisation

▶ 开关阀类型: 球阀 / Shutoff: with ball valve

▶ 开关方式: 手柄 / Opening: by operating handle

泡沫比例混合器 / Eductor

▶ 材料: 不锈钢 / Material: stainless steel

▶ 吸液比例: 3% / Suction percentage: 3%

▶ 止回阀 / Non-return valve

泡沫消防卷盘 - 400 升/分 - DN38
Foam hose reel - 400 lpm - DN38

最大工作压力: PN16 / Maximum working pressure: PN16

液罐 / Tank

材料: 不锈钢 / Material: stainless steel

消防枪 / Nozzle

材料: 铝合金 / Material: aluminium alloy

▶ 表面处理: 聚酯涂层和硬质阳极氧化

Surface treatment: polyester coated and hard anodisation

▶ 开关阀类型: 球阀 / Shutoff: with ball valve

▶ 开关方式: 手柄 / Opening: by operating handle

泡沫比例混合器 / Eductor

材料: 青铜 / Material: bronze

▶ 吸液比例: 3% / Suction percentage: 3%

▶ 止回阀 / Non-return valve

接口*

COUPLINGS*

*根据客户需求可配备不同形式的接口

*Products can be equipped with other types of couplings if needed



STORZ

NST

GFR

MACHINO

GOST

DSP

BARCELONA

INSTANTANEOUS

PLA_01105_Flyer CH-EN_海上_Marine



POK CHINA

博克消防装备科技有限公司

地址: 北京市顺义区南彩镇彩达三街一号茂华工场5号厂房2层201室 · POK

电话: 010 64667868

邮箱: info@pokchina.com sales@pokchina.com

www.pokchina.com



- TYCO SEA PLUS (KOREA)
- MARINE ESPAGNOLE (SPAIN)
- MARINE ITALIENNE (ITALY)
- US NAVY (USA)
- MARINE NATIONALE (FRANCE)
- DCNS (FRANCE)
- BCRM (FRANCE)

海上
MARINE



充满激情的创造者 / WE CREATE WITH PASSION



DN80固定式不锈钢消防炮
MERCATOR - DN80 FIXED MONITOR

- ▶ 最大工作压力: PN16 / Working pressure: PN16
- ▶ 流量: 3000 升/分 / Flow rate: 3000 lpm
- ▶ 入口: 法兰 DN80 PN16 / Inlet: flange DN80 PN16
- ▶ 材料: 不锈钢 / Material: stainless steel
- ▶ 水平旋转角: 360° / Horizontal movement: on 360°
- ▶ 水平旋转调整方式: 手柄 / Horizontal adjustment: by handle
- ▶ 垂直俯仰角: -60至+80° / Vertical movement: from -60° to +80°
- ▶ 垂直俯仰调整方式: 手柄 / Vertical adjustment: by handle
- ▶ 选项: 出口装备, 法兰。 / Options: outlet equipment, flange

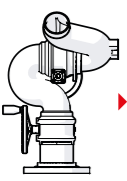

电动控制青铜消防炮
DN80 FIXED MONITOR IN BRONZE

- ▶ 最大工作压力: PN16 / Working pressure: PN16
- ▶ 流量: 5000 升/分 / Flow rate: 5000 lpm
- ▶ 入口: 法兰 4" ASA150 / Inlet: Flange 4" ASA150
- ▶ 材料: 青铜 / Material: bronze
- ▶ 水平旋转角: 360° / Horizontal movement: on 360°
- ▶ 水平旋转调整方式: 手轮手动、手柄或链条 / Horizontal adjustment: by handwheels, by handle or by chains
- ▶ 垂直俯仰角: -60至+80° / Vertical movement: from -60° to +85°
- ▶ 垂直俯仰调整方式: 手轮手动、手柄或链条 / Vertical adjustment: by handwheels, by handle or by chains
- ▶ 选项: 出口装备, 法兰。 / Options: outlet equipment, flange

炮头
DIFFUSERS

自吸式 / SELF-EDUCING
不锈钢 / DEBIKA INOX

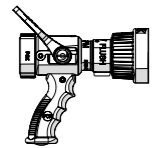

消防水枪
HAND NOZZLE

- ▶ POKABRONZE / POKABRONZE
- ▶ TURBOKADOR / TURBOKADOR
- ▶ LEGENDE 带或不带扳机 / LEGENDE with or without trigger

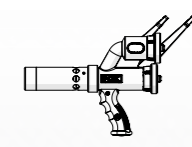

干粉/泡沫枪 «COMBIPOWDER»
"COMBIPOWDER" POWDER-FOAM NOZZLE

- ▶ 最大工作压力: PN16 / Working pressure: PN16
- ▶ 流量: 400 升/分 / Flow rate water: 400 lpm
- ▶ 干粉流量: 5 kg/s / Flow rate powder: 5 kg/s
- ▶ 材料: 铝合金和硬质阳极氧化 / Material: aluminium alloy and hard anodisation
- ▶ 表面处理: 聚酯涂层 / Surface treatment: polyester
- ▶ 开关阀类型: 球阀 / Valve type: ball valve
- ▶ 开关方式: 手柄 / Operation: by lever
- ▶ 手枪式握柄 / Pistol handle
- ▶ 发泡倍数: x10 / Expansion: approx. x10
- ▶ 射程: 27米 (法国海军测量值) / Range: 27m (measured by the French Navy)

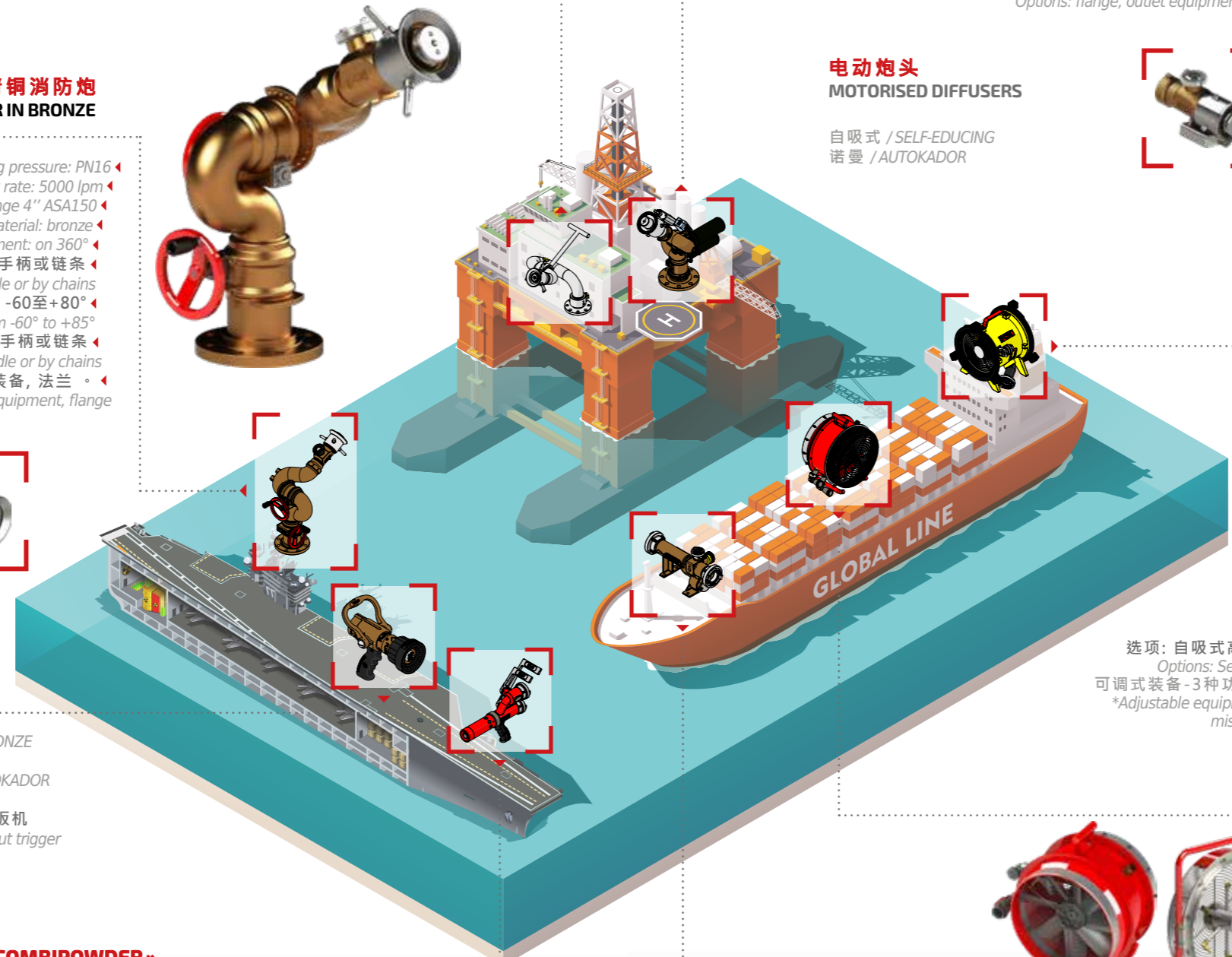
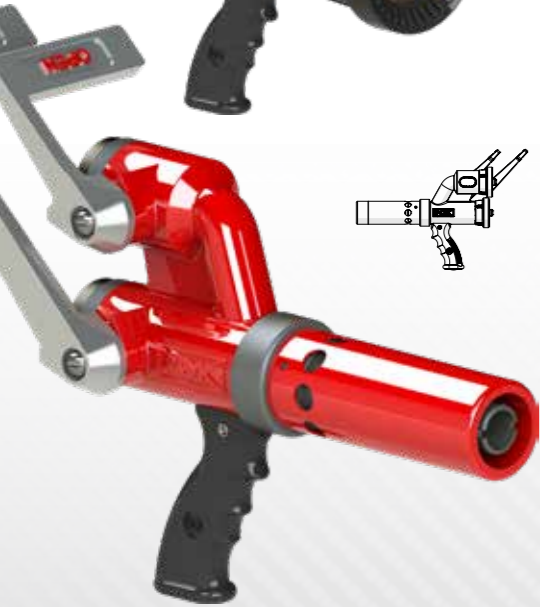

DN65固定式电控消防炮
MOTORIZED DN65 FIXED MONITOR

- ▶ 最大工作压力: PN16 / Working pressure: PN16
- ▶ 流量: 2000 升/分 / Flow rate: 2000 lpm
- ▶ 入口: 法兰 3" 或 4" ASA150 / Inlet: Flange 3" or 4" ASA150
- ▶ 材料: 青铜 / Material: bronze
- ▶ 水平旋转角: -170° 到 +170° / Horizontal movement: from -170° to +170°
- ▶ 水平旋转调整方式: 电动和螺栓 / Horizontal adjustment: motorised and spare screw
- ▶ 垂直俯仰角: -37° 到 +85° / Vertical movement: from -37° to +85°
- ▶ 垂直俯仰调整方式: 电动和螺栓 / Vertical adjustment: motorised and spare screw
- ▶ 供电电压: 24V DC / Power supply: 24V CC
- ▶ 动作速: 22°/秒 / Speed: 22°/s
- ▶ 选项: 法兰, 出口装备, 控制系统。 / Options: flange, outlet equipment, control system



电动炮头
MOTORIZED DIFFUSERS

自吸式 / SELF-EDUCING
诺曼 / AUTOKADOR

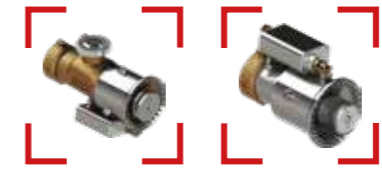

高倍数泡沫发生器
MISTRAL-DN 300
MISTRAL 300 FANS

- ▶ 最大工作压力: PN16 / Working pressure: PN16
- ▶ 额定工作压力: 7 公斤 / Working pressure: 7 bar
- ▶ 材料: 铝合金 / Material: aluminium alloy
- ▶ 搬运手柄 / Lift handle
- ▶ 表面处理: 聚酯涂层 / Surface treatment: polyester coating
- ▶ 选项: 自吸式高倍数泡沫发生器, 带筛网的泡沫管。 / Options: Self-educing device, foam expansion with mesh
- ▶ 可调式装备-3种功效: 高倍数泡沫发生器, 雾化, 通风排烟。 / Adjustable equipment - 3 functions: high expansion foam generator, misting and ventilation, discharge of fumes and smoke



高倍数泡沫发生器
FOAM GENERATOR

- ▶ 高倍数 DN500 / High expansion DN500
- ▶ 最大工作压力: PN16 / Working pressure: PN16
- ▶ 流量: 225 升/分 / Flow rate: 225 lpm
- ▶ 铝合金和不锈钢 / Material: aluminium alloy and stainless steel
- ▶ 表面处理: 聚酯涂层和硬质阳极氧化 / Surface treatment: polyester coating and hard anodisation
- ▶ 搬运手柄 / Lift handle
- ▶ 发泡倍数: 500倍至1200倍 / Expansion: from x500 to x1200

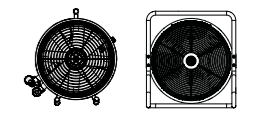

青铜泡沫比例混合器
EDUCTORS IN BRONZE

- ▶ 最大工作压力: PN16 / Working pressure: PN16
- ▶ 流量: 200 至 800 升/分 / Flow rate: 200 to 800 lpm
- ▶ 材质: 青铜 / Material: bronze
- ▶ 止回阀 / Non-return valve
- ▶ 配吸液软管 / Supplied with pick-up tube
- ▶ 表面处理: 粗糙 / Surface treatment: rough
- ▶ 控制阀 / Control valve
- ▶ 选项: 混合比定量阀, 200升/分和400升/分的比例混合器 / Options: metering device 0,1%, 0,5% and 1% for 200 and 400 lpm eductors, inlet and outlets couplings

